

ZXMS6005SG
60V N-CHANNEL SELF PROTECTED ENHANCEMENT MODE
INTELLIFET™ MOSFET

SUMMARY

Continuous drain source voltage 60 V

On-state resistance 200 mΩ

Nominal load current (V_{IN} = 5V) 2 A

Clamping Energy 480 mJ

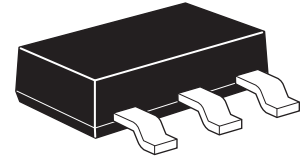

SOT223 Package

DESCRIPTION

The ZXMS6005SG is a self protected low side MOSFET with logic level input. It integrates over-temperature, over-current, over-voltage (active clamp) and ESD protected logic level functionality. The ZXMS6005SG is ideal as a general purpose switch driven from 3.3V or 5V microcontrollers in harsh environments where standard MOSFETs are not rugged enough.

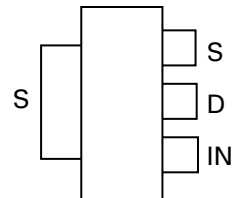

FEATURES

- Compact high power dissipation package
- Low input current
- Logic Level Input (3.3V and 5V)
- Short circuit protection with auto restart
- Over voltage protection (active clamp)
- Thermal shutdown with auto restart
- Over-current protection
- Input Protection (ESD)
- High continuous current rating

ORDERING INFORMATION

DEVICE	PART MARK	REEL SIZE (inches)	TAPE WIDTH (mm)	QUANTITY PER REEL
ZXMS6005SGTA	ZXMS 6005S	7	12 embossed	1,000 units

FUNCTIONAL BLOCK DIAGRAM

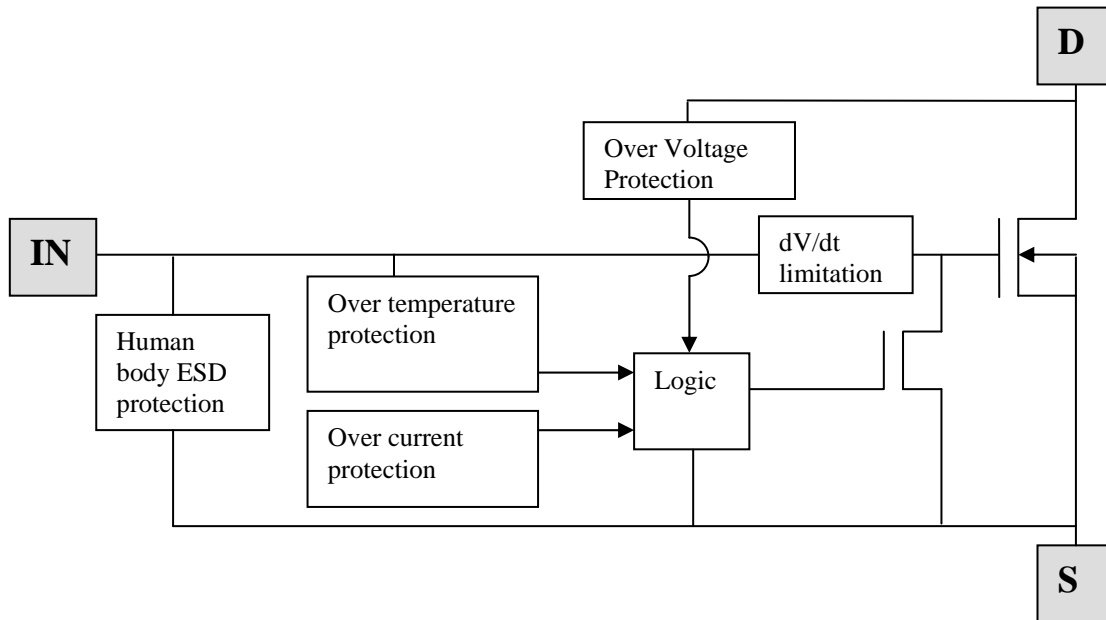

APPLICATIONS AND INFORMATION

- Especially suited for loads with a high in-rush current such as lamps and motors.
- All types of resistive, inductive and capacitive loads in switching applications.
- μC compatible power switch for 12V DC applications.
- Automotive rated.
- Replaces electromechanical relays and discrete circuits.
- Linear Mode capability - the current-limiting protection circuitry is designed to de-activate at low V_{DS} to minimise on state power dissipation. The maximum DC operating current is therefore determined by the thermal capability of the package/board combination, rather than by the protection circuitry. This does not compromise the product's ability to self-protect at low V_{DS} .

ABSOLUTE MAXIMUM RATINGS

PARAMETER	SYMBOL	LIMIT	UNIT
Continuous Drain-Source Voltage	V_{DS}	60	V
Drain-Source Voltage for short circuit protection	$V_{DS(SC)}$	24	V
Continuous Input Voltage	V_{IN}	-0.5 ... +6	V
Continuous Input Current -0.2V ≤ V_{IN} ≤ 6V V_{IN} < -0.2V or V_{IN} > 6V	I_{IN}	No limit $ I_{IN} \leq 2$	mA
Operating Temperature Range	T_j	-40 to +150	°C
Storage Temperature Range	T_{stg}	-55 to +150	°C
Power Dissipation at $T_A = 25^\circ\text{C}$ (a)	P_D	1.0	W
Linear Derating Factor		8.0	mW/°C
Power Dissipation at $T_A = 25^\circ\text{C}$ (b)	P_D	1.6	W
Linear Derating Factor		12.8	mW/°C
Pulsed Drain Current @ $V_{IN} = 3.3\text{V}$	I_{DM}	5	A
Pulsed Drain Current @ $V_{IN} = 5\text{V}$	I_{DM}	6	A
Continuous Source Current (Body Diode) (a)	I_S	2.5	A
Pulsed Source Current (Body Diode)	I_{SM}	10	A
Unclamped single pulse inductive energy, $T_j = 25^\circ\text{C}$, $I_D = 0.5\text{A}$, $V_{DD} = 24\text{V}$	E_{AS}	480	mJ
Electrostatic Discharge (Human Body Model)	V_{ESD}	4000	V
Charged Device Model	V_{CDM}	1000	V

THERMAL RESISTANCE

PARAMETER	SYMBOL	VALUE	UNIT
Junction to Ambient (a)	$R_{\theta JA}$	125	°C/W
Junction to Ambient (b)	$R_{\theta JA}$	83	°C/W
Junction to Case (c)	$R_{\theta JC}$	39	°C/W

NOTES

- For a device surface mounted on 15mm x 15mm single sided 1oz weight copper on 1.6mm FR4 board, in still air conditions. Sink split drain 80% and source 20% to isolate connections.
- For a device surface mounted on 50mm x 50mm single sided 2oz weight copper on 1.6mm FR4 board, in still air conditions. Sink split drain 80% and source 20% to isolate connections.
- Thermal resistance between junction and the mounting surfaces of drain and source pins.

RECOMMENDED OPERATING CONDITIONS

The ZXMS6005SG is optimised for use with μC operating from 3.3V and 5V supplies.

Symbol	Description	Min	Max	Units
V_{IN}	Input voltage range	0	5.5	V
T_A	Ambient temperature range	-40	125	$^{\circ}\text{C}$
V_{IH}	High level input voltage for MOSFET to be on	3	5.5	V
V_{IL}	Low level input voltage for MOSFET to be off	0	0.7	V
V_P	Peripheral supply voltage (voltage to which load is referred)	0	24	V

CHARACTERISTICS

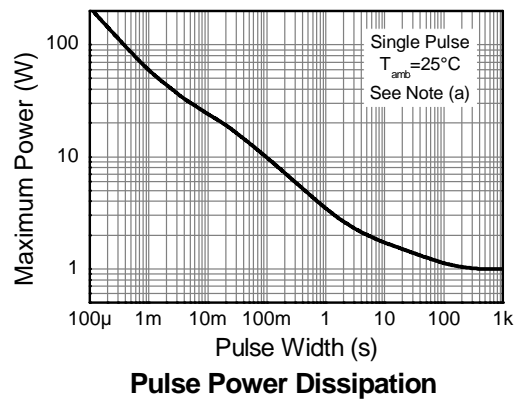
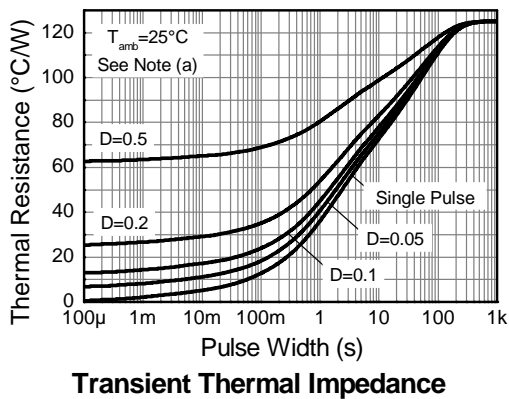
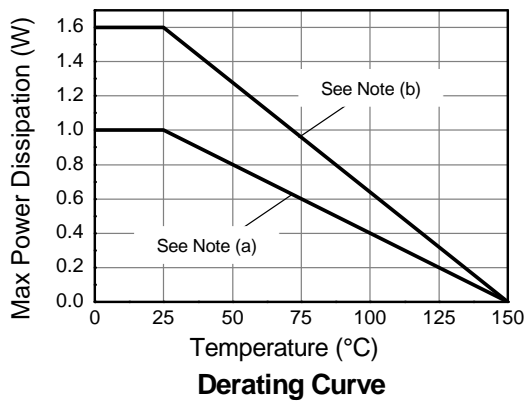
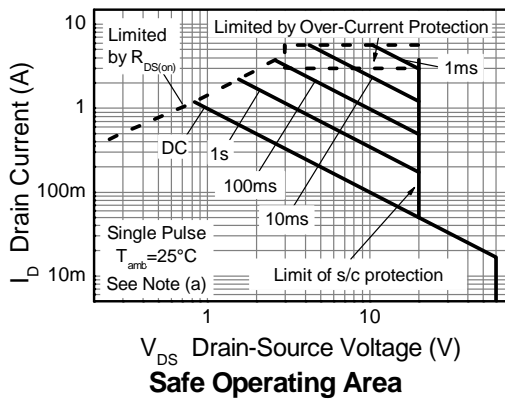

ELECTRICAL CHARACTERISTICS (at $T_{amb} = 25^{\circ}\text{C}$ unless otherwise stated).

PARAMETER	SYMBOL	MIN	TYP	MAX	UNIT	CONDITIONS
Static Characteristics						
Drain-Source Clamp Voltage	$V_{DS(AZ)}$	60	65	70	V	$I_D=10\text{mA}$
Off state Drain Current	I_{DSS}			1	μA	$V_{DS}=12\text{V}, V_{IN}=0\text{V}$
Off state Drain Current	I_{DSS}			2	μA	$V_{DS}=36\text{V}, V_{IN}=0\text{V}$
Input Threshold Voltage	$V_{IN(th)}$	0.7	1	1.5	V	$V_{DS}=V_{GS}, I_D=1\text{mA}$
Input Current	I_{IN}		60	100	μA	$V_{IN}=+3\text{V}$
Input Current	I_{IN}		120	200	μA	$V_{IN}=+5\text{V}$
Input Current while over temperature active				300	μA	$V_{IN}=+5\text{V}$
Static Drain-Source On-State Resistance	$R_{DS(on)}$		170	250	$\text{m}\Omega$	$V_{IN}=+3\text{V}, I_D=1\text{A}$
Static Drain-Source On-State Resistance	$R_{DS(on)}$		150	200	$\text{m}\Omega$	$V_{IN}=+5\text{V}, I_D=1\text{A}$
Continuous Drain Current (a)	I_D	1.4			A	$V_{IN}=3\text{V}; T_A=25^{\circ}\text{C}$
Continuous Drain Current (a)	I_D	1.6			A	$V_{IN}=5\text{V}; T_A=25^{\circ}\text{C}$
Continuous Drain Current (b)	I_D	1.9			A	$V_{IN}=3\text{V}; T_A=25^{\circ}\text{C}$
Continuous Drain Current (b)	I_D	2.0			A	$V_{IN}=5\text{V}; T_A=25^{\circ}\text{C}$
Current Limit (d)	$I_{D(LIM)}$	2.2	5		A	$V_{IN}=+3\text{V},$
Current Limit (d)	$I_{D(LIM)}$	3.3	7		A	$V_{IN}=+5\text{V}$
Dynamic Characteristics						
Turn On Delay Time	$t_{d(on)}$		6		μs	$V_{DD}=12\text{V}, I_D=1\text{A}, V_{GS}=5\text{V}$
Rise time	t_r		14		μs	
Turn Off Delay Time	$t_{d(off)}$		34		μs	
Fall Time	f_f		19		μs	

Notes:

- (d) The drain current is restricted only when the device is in saturation (see graph 'typical output characteristic'). This allows the device to be used in the fully on state without interference from the current limit. The device is fully protected at all drain currents, as the low power dissipation generated outside saturation makes current limit unnecessary.

PARAMETER	SYMBOL	MIN	TYP	MAX	UNIT	CONDITIONS
Over-temperature Protection						
Thermal Overload Trip Temperature (e)	T _{JT}	150	175		°C	
Thermal hysteresis (e)			10		°C	

Note:

- (e) Over-temperature protection is designed to prevent device destruction under fault conditions. Fault conditions are considered as “outside” normal operating range, so this part is not designed to withstand over-temperature for extended periods..

TYPICAL CHARACTERISTICS

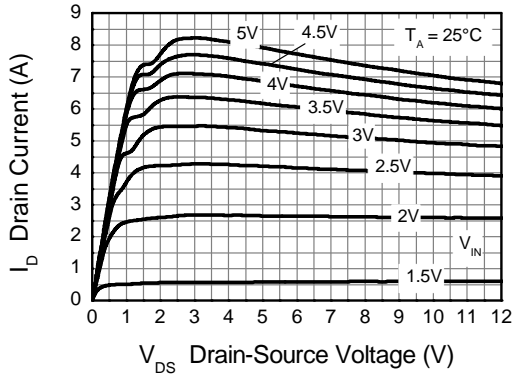

Typical Output Characteristic

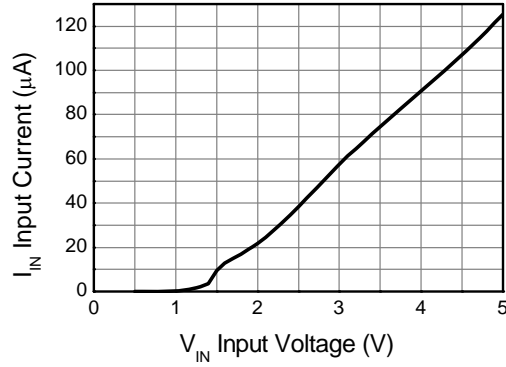

Input Current vs Input Voltage

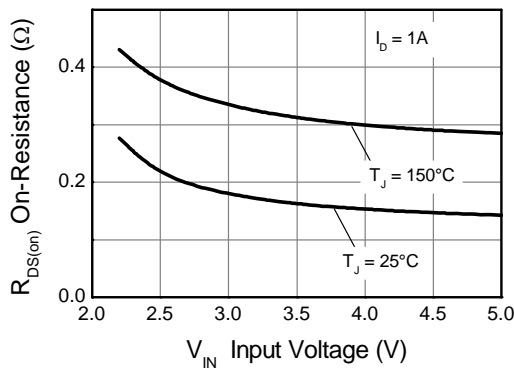

On-Resistance vs Input Voltage

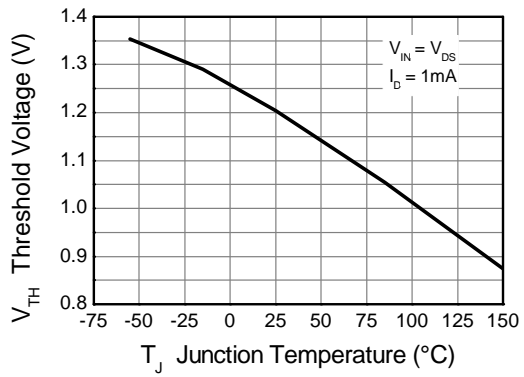

Threshold Voltage vs Temperature

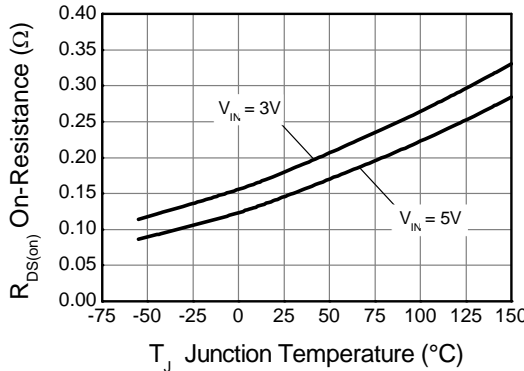

On-Resistance vs Temperature

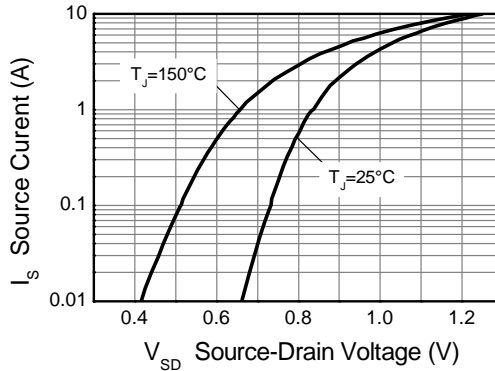

Reverse Diode Characteristic

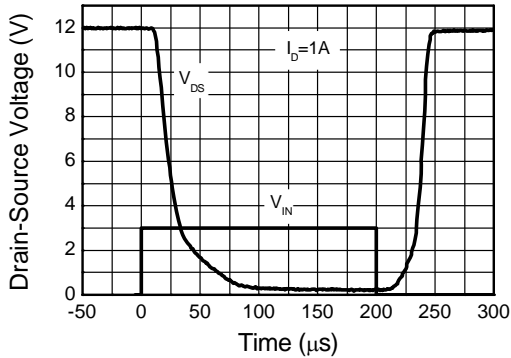

Switching Speed

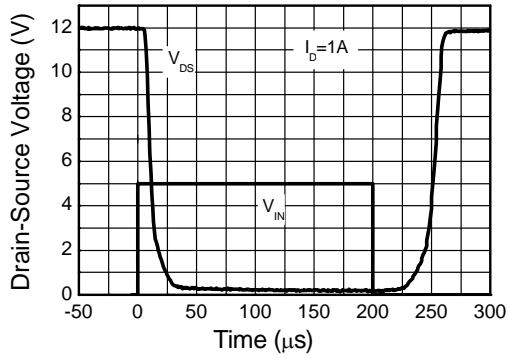

Switching Speed

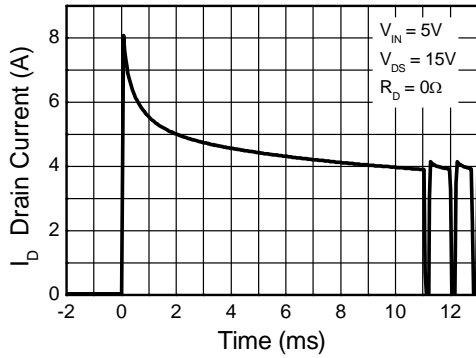

Typical Short Circuit Protection

IMPORTANT NOTICE

DIODES INCORPORATED MAKES NO WARRANTY OF ANY KIND, EXPRESS OR IMPLIED, WITH REGARDING TO THIS DOCUMENT, INCLUDING, BUT NOT LIMITED TO, THE IMPLIED WARRANTIES OF MERCHANTABILITY AND FITNESS FOR A PARTICULAR PURPOSE (AND THEIR EQUIVALENTS UNDER THE LAWS OF ANY JURISDICTION).

Diodes Incorporated and its subsidiaries reserve the right to make modifications, enhancements, improvements, corrections or other changes without further notice to this document and any product described herein. Diodes Incorporated does not assume any liability arising out of the application or use of this document or any product described herein; neither does Diodes Incorporated convey any license under its patent or trademark rights, nor the rights of others. Any Customer or user of this document or products described herein in such applications shall assume all risks of such use and will agree to hold Diodes Incorporated and all the companies whose products are represented on Diodes Incorporated website, harmless against all damages.

Diodes Incorporated does not warrant or accept any liability whatsoever in respect of any products purchased through unauthorized sales channel.

Should Customers purchase or use Diodes Incorporated products for any unintended or unauthorized application, Customers shall indemnify and hold Diodes Incorporated and its representatives harmless against all claims, damages, expenses, and attorney fees arising out of, directly or indirectly, any claim of personal injury or death associated with such unintended or unauthorized application.

Products described herein may be covered by one or more United States, international or foreign patents pending. Product names and markings noted herein may also be covered by one or more United States, international or foreign trademarks.

LIFE SUPPORT

Diodes Incorporated products are specifically not authorized for use as critical components in life support devices or systems without the express written approval of the Chief Executive Officer of Diodes Incorporated. As used herein:

A. Life support devices or systems are devices or systems which:

1. are intended to implant into the body, or
2. support or sustain life and whose failure to perform when properly used in accordance with instructions for use provided in the labeling can be reasonably expected to result in significant injury to the user.

B. A critical component is any component in a life support device or system whose failure to perform can be reasonably expected to cause the failure of the life support device or to affect its safety or effectiveness.

Customers represent that they have all necessary expertise in the safety and regulatory ramifications of their life support devices or systems, and acknowledge and agree that they are solely responsible for all legal, regulatory and safety-related requirements concerning their products and any use of Diodes Incorporated products in such safety-critical, life support devices or systems, notwithstanding any devices- or systems-related information or support that may be provided by Diodes Incorporated. Further, Customers must fully indemnify Diodes Incorporated and its representatives against any damages arising out of the use of Diodes Incorporated products in such safety-critical, life support devices or systems.

Copyright © 2010, Diodes Incorporated

www.diodes.com